

HITCAM USER MANUAL

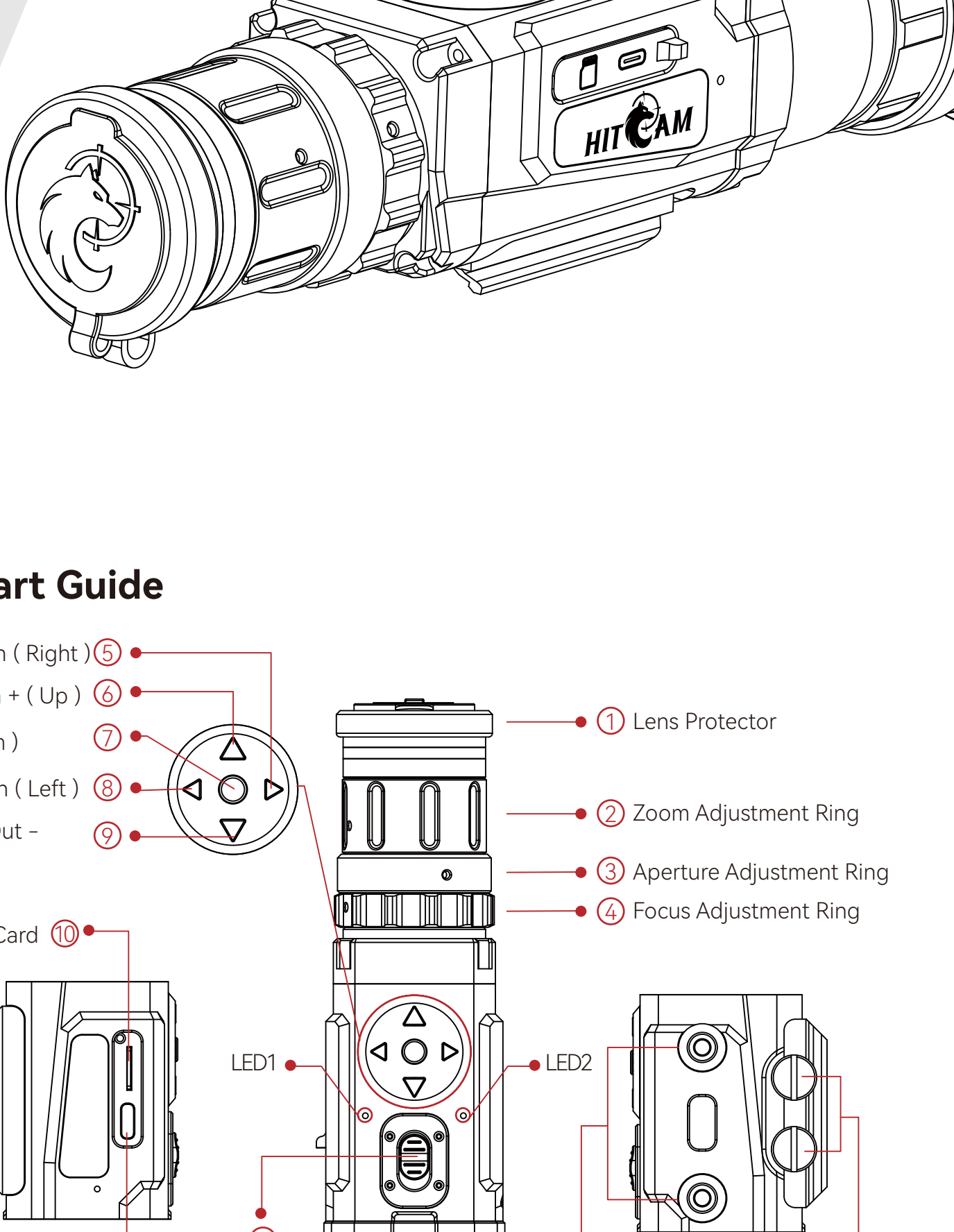

Quickstart Guide

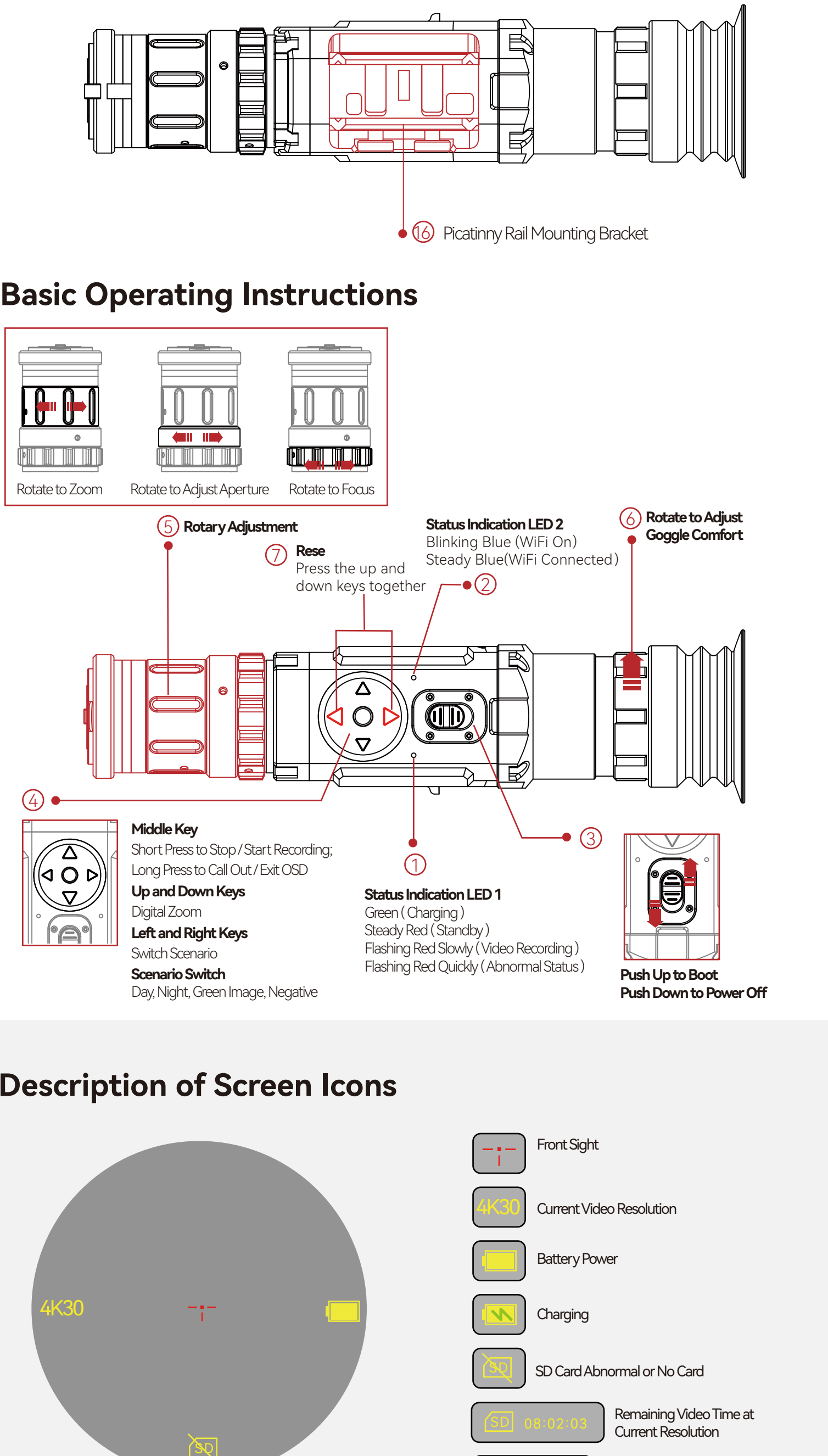

Basic Operating Instructions

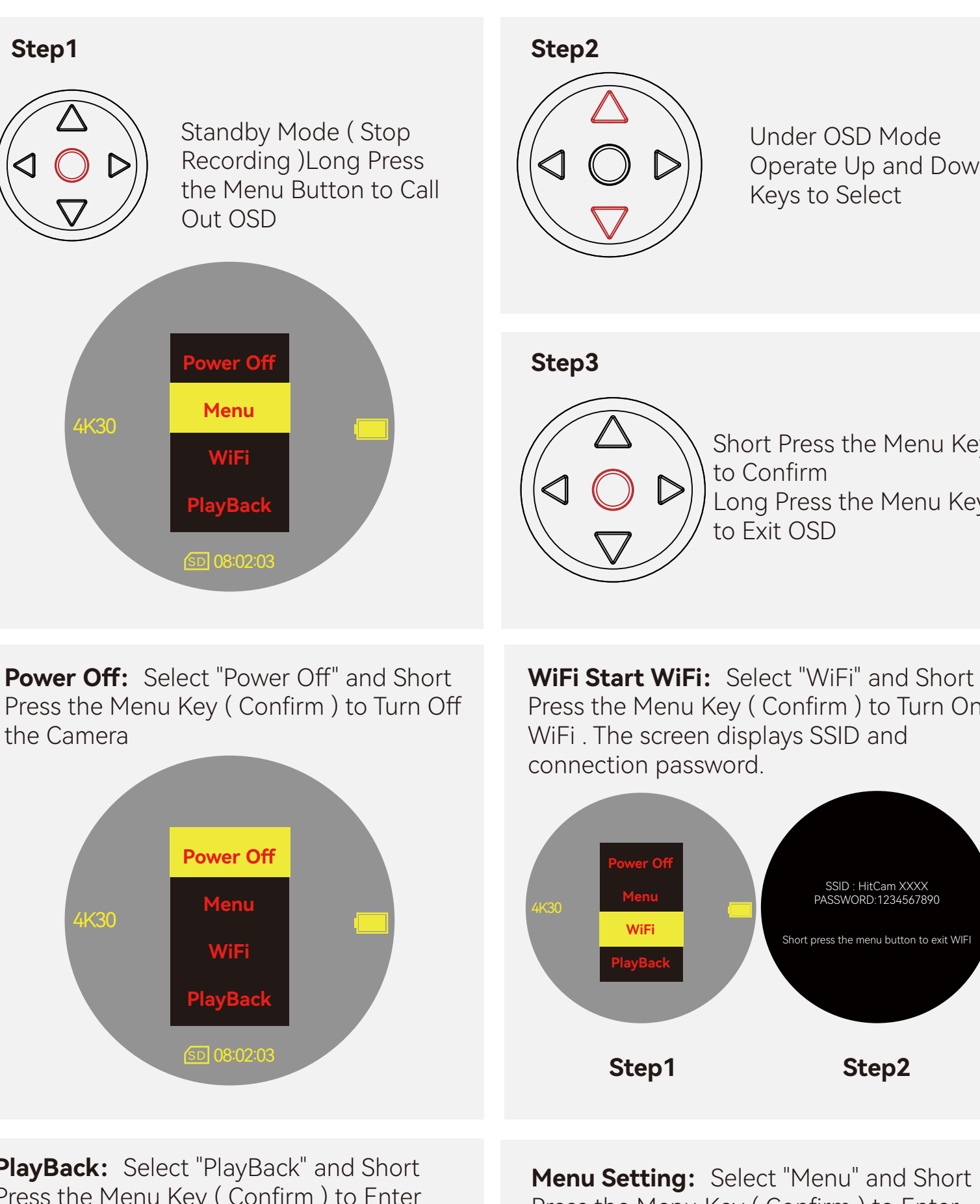

Description of Screen Icons

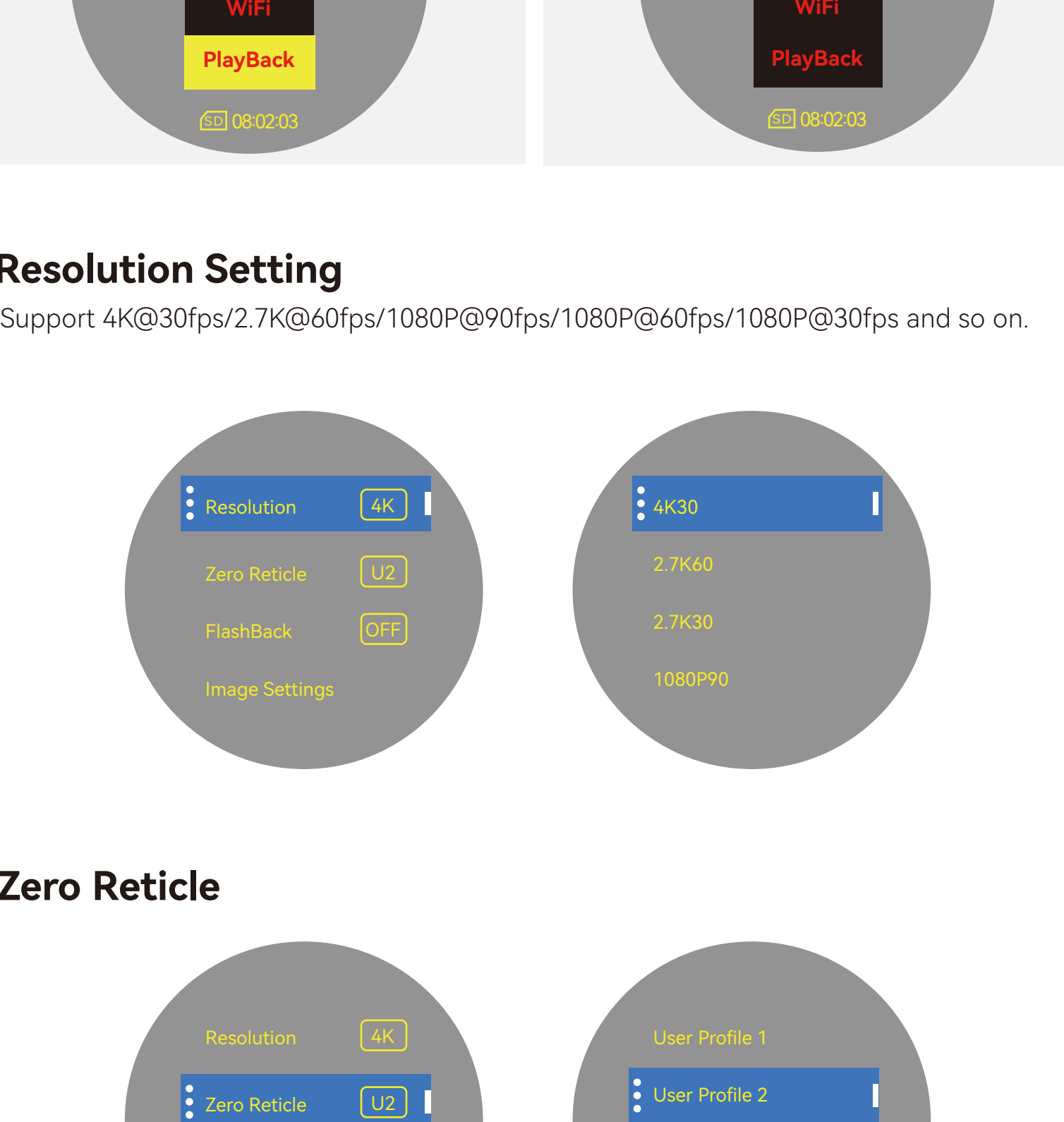

OSD Operating Instructions

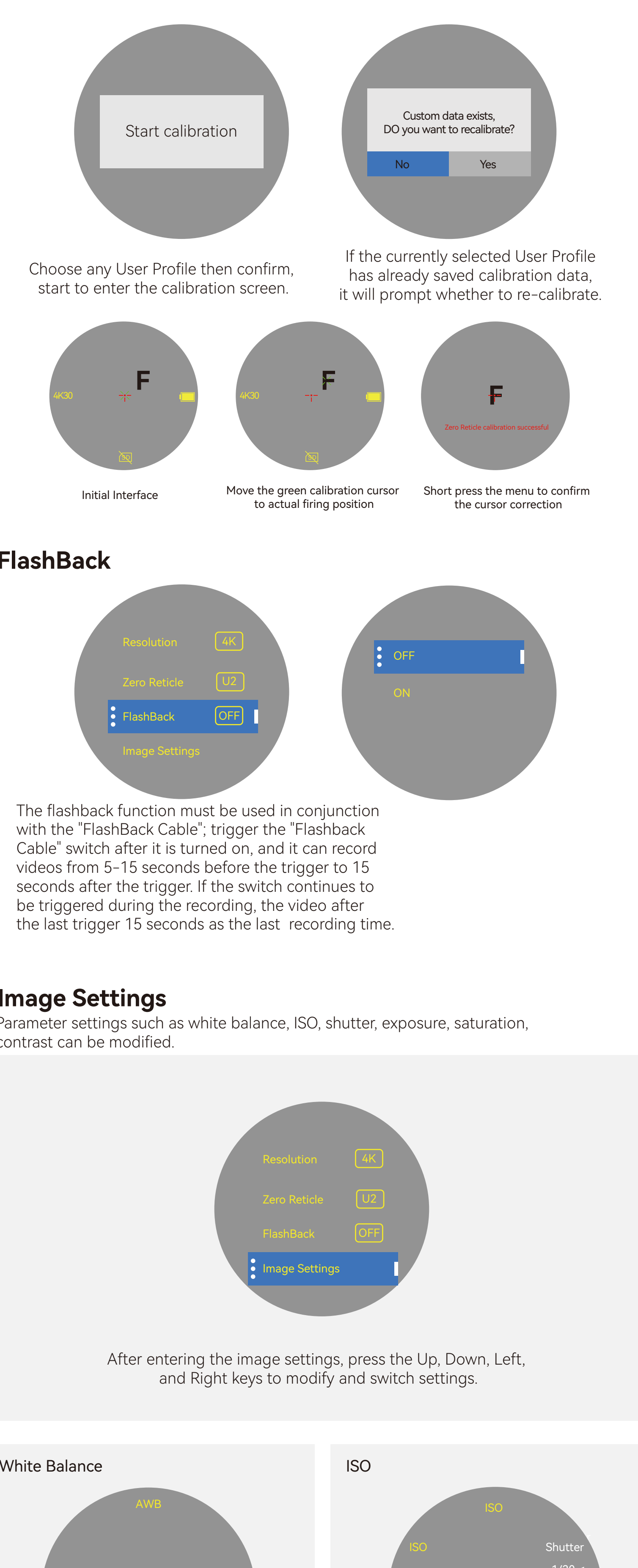

Resolution Setting

Support 4K@30fps/2.7K@60fps/1080P@90fps/1080P@60fps/1080P@30fps and so on.

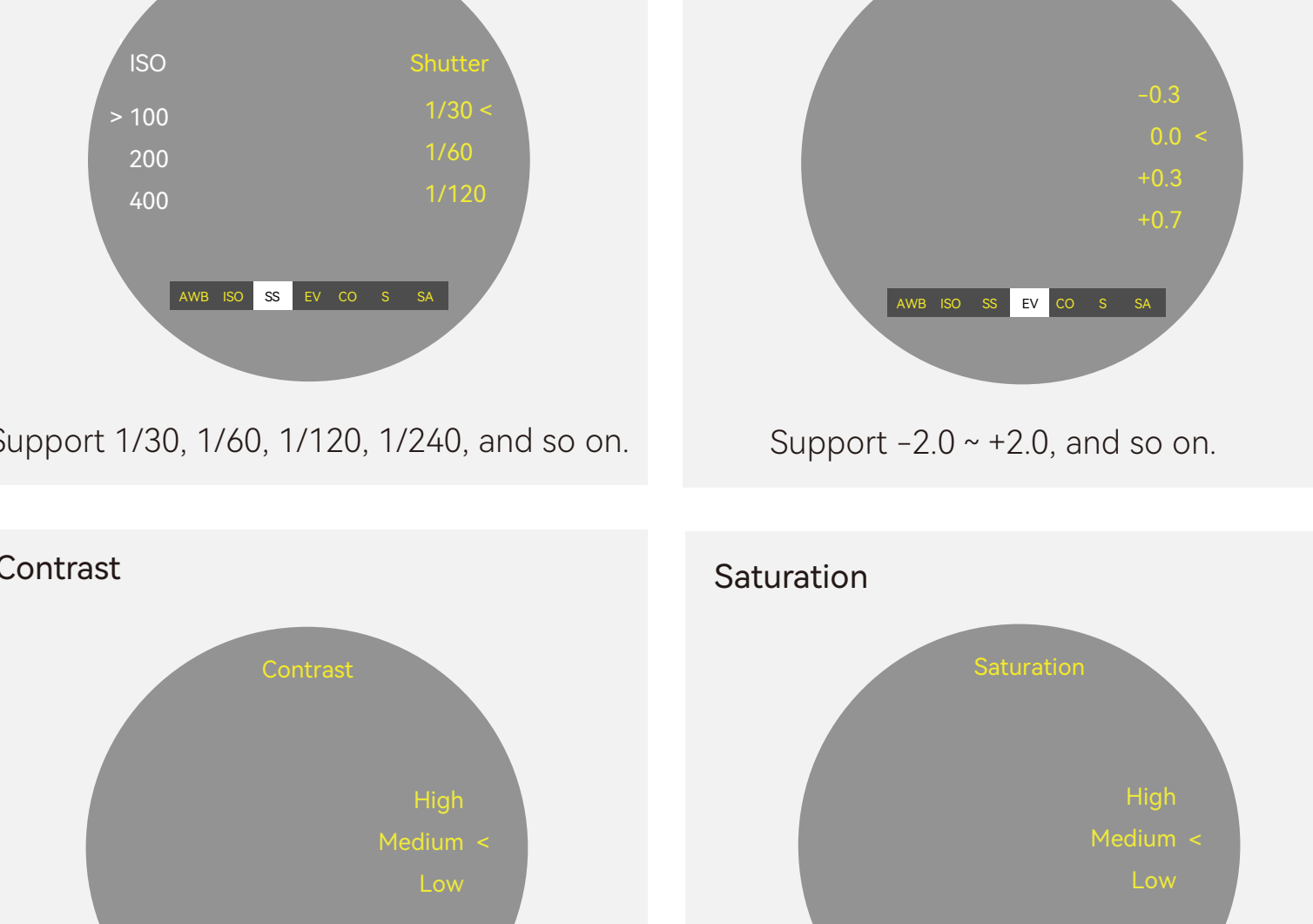

Zero Reticle

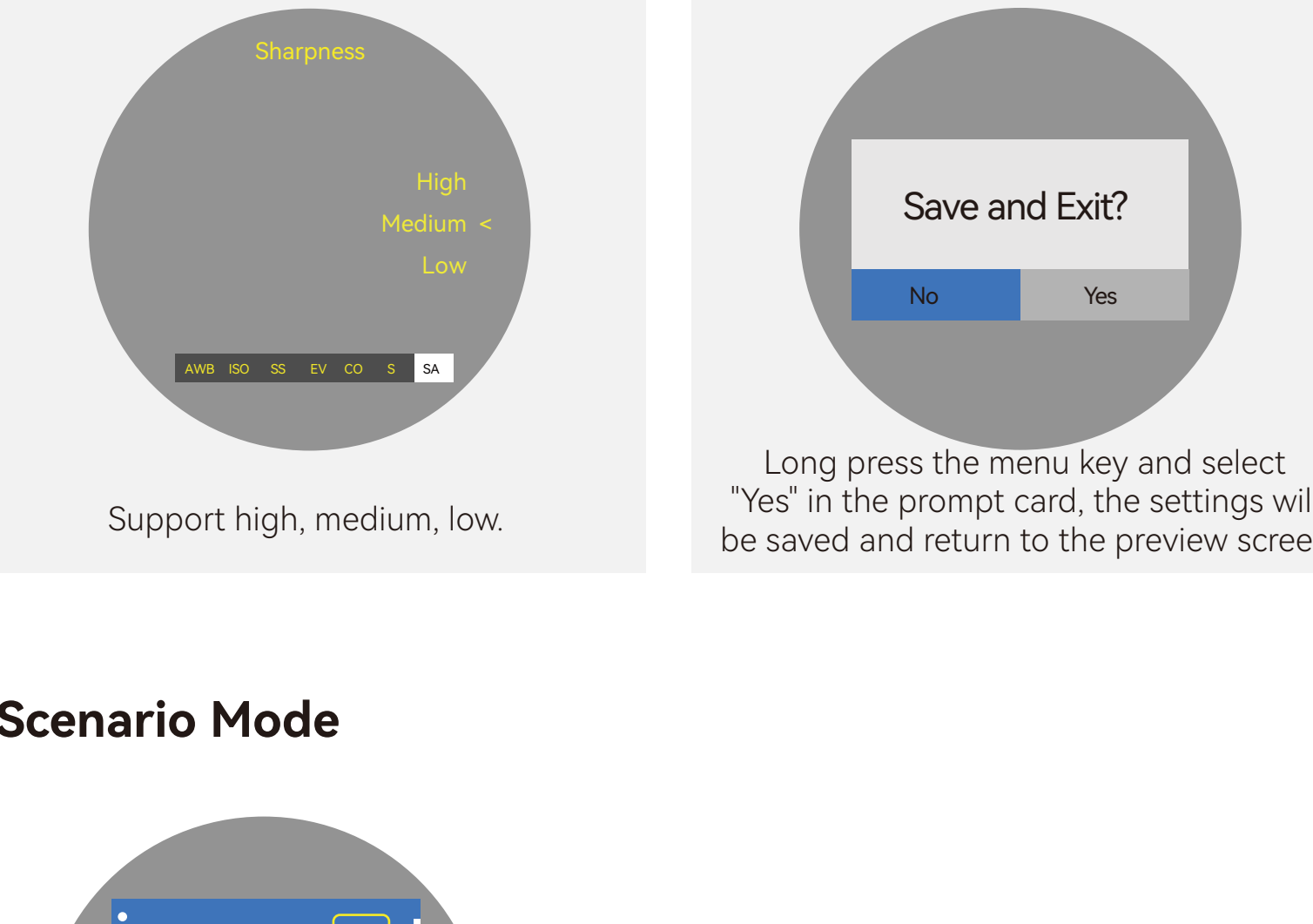

Zero Reticle Operation Diagram



FlashBack



The flashback function must be used in conjunction with the "FlashBack Cable"; trigger the "Flashback Cable" switch after it is turned on, and it can record videos from 5-15 seconds before the trigger to 15 seconds after the trigger. After the last trigger 15 seconds as the last recording time.

Image Settings

Parameter settings such as white balance, ISO, shutter, exposure, saturation, contrast can be modified.

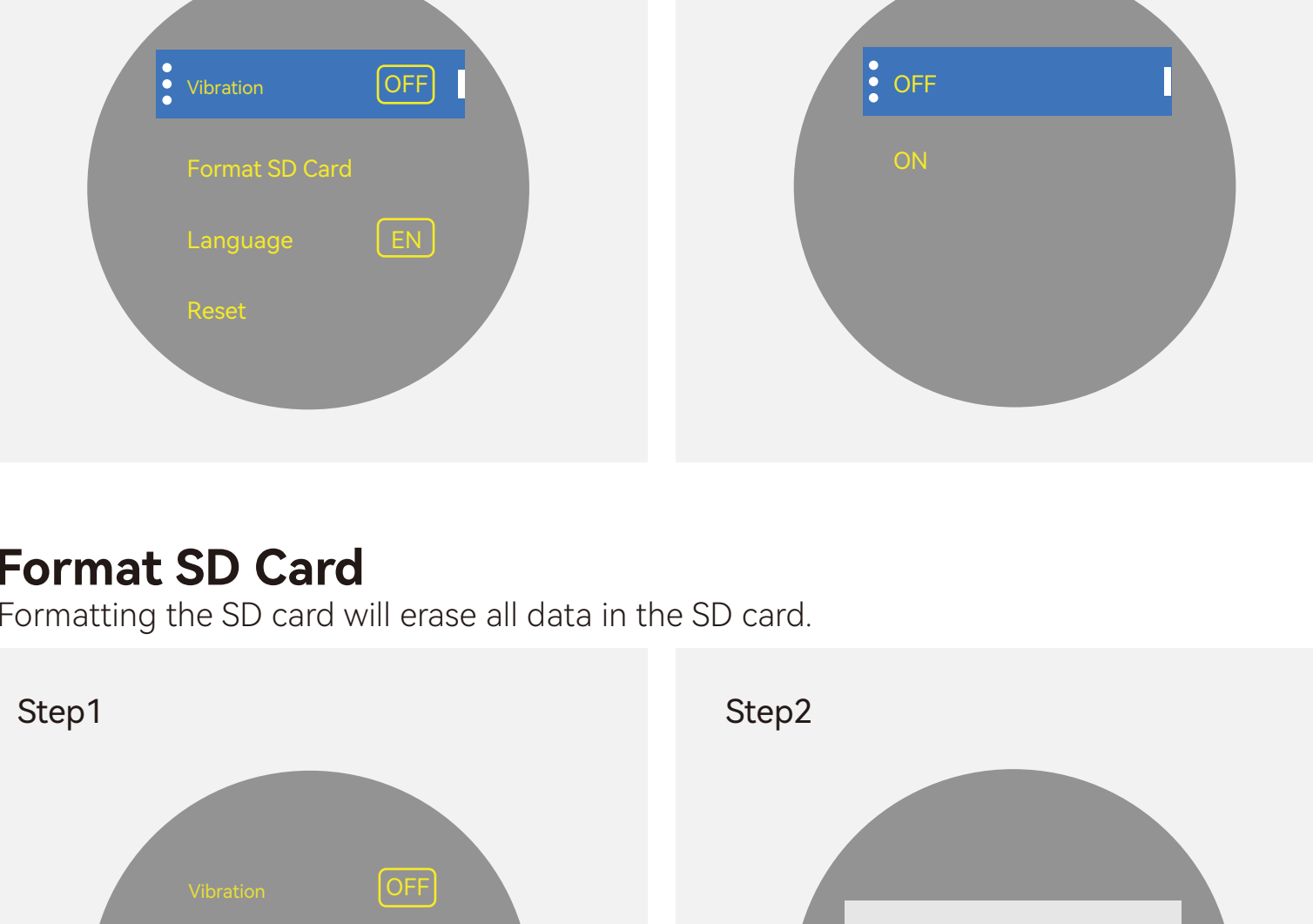

After entering the image settings, press the Up, Down, Left, and Right keys to modify and switch settings.

White Balance

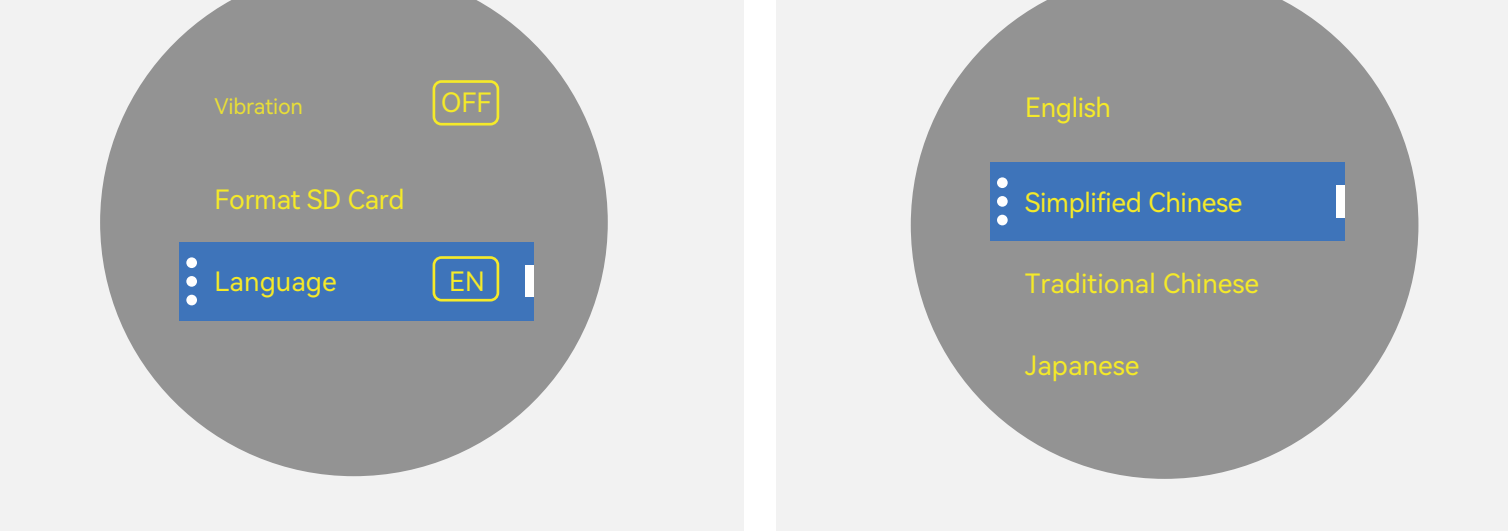

Support automatic, sunny, cloudy, and so on.

ISO



Support 100, 200, 400, 800, 1600, 3200, and so on.

Shutter

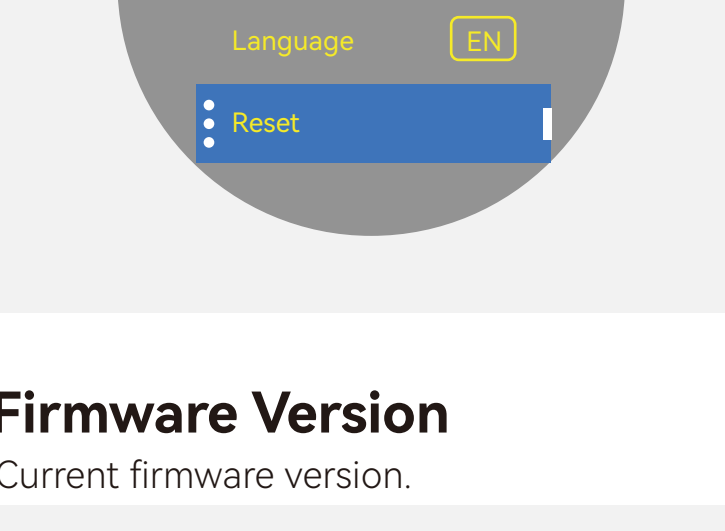

Support 1/30, 1/60, 1/120, 1/240, and so on.

Exposure

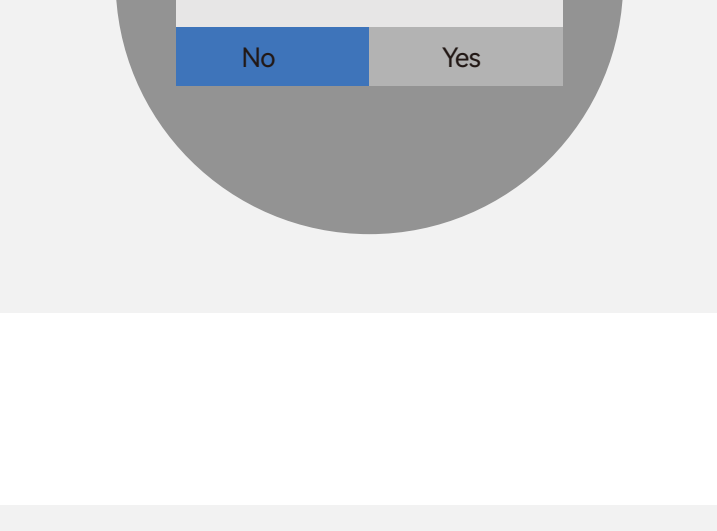

Support -2.0 ~ +2.0, and so on.

Contrast

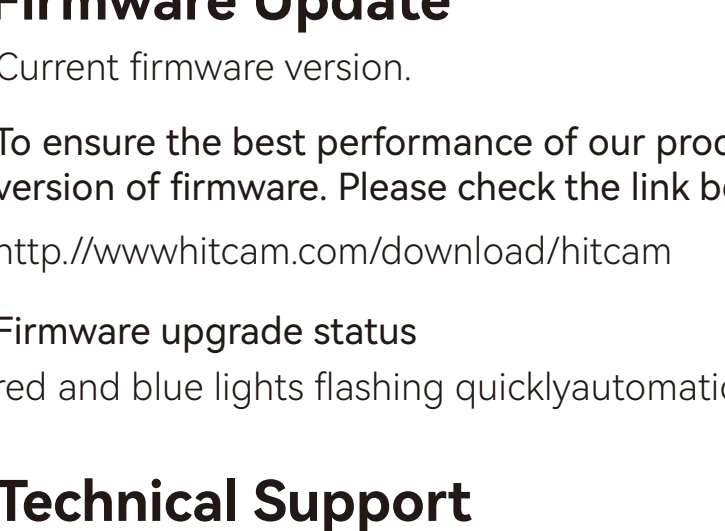

Support high, medium, low.

Saturation

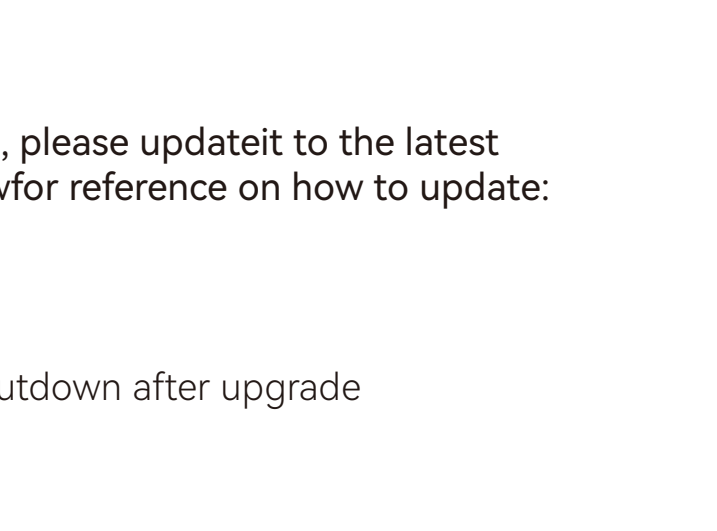

Support high, medium, low.

Sharpness

Support high, medium, low.

Save and Exit

Long press the menu key and select "Yes" in the prompt card, the settings will be saved and return to the preview screen.

Scenario Mode

Support 4 modes, after selection, you can see the actual picture effect on the screen, and the video recording is also by the current effect (It also can be done under preview by using the Left and Right keys to quickly switch) Scenario Description.

Scenario Description

Day (Color)
Night (Black and White & Infraration Supported)
Green Image (Infraration Supported)
Negative

LoopRecording

The loop recording function is enabled by selecting 1, 3, 5Minutes and other recording durations. When enabling, when the capacity of the SD card is insufficient, the old video files will be automatically deleted to make room for new video files.

Recording Volume

Set the volume of the recording, which can be set to low, medium (default), and high respectively.

Auto PowerOff

After this setting is on, if there is no operation within the set time, it will automatically shut down. 1Min, 3Min, 5Min can be set respectively.

Vibration

After opening, there will be vibration when powering on, recording, stopping recording, etc.

Format SD Card

Formatting the SD card will erase all data in the SD card.

Language

Support English, Simplified Chinese, Traditional Chinese, Japanese and so on.

Reset

After selecting and confirming, the factory settings will be restored.

Firmware Version

Current firmware version.

Firmware Update

Current firmware version.

To ensure the best performance of our product, please update it to the latest version of firmware. Please check the link below for reference on how to update:

<http://www.hitcam.com/download/hitcam>

Firmware upgrade status

Red and blue lights flashing quickly automatic shutdown after upgrade

Technical Support

<http://www.hitcam.com/support/en-us>